

SECTION A-A

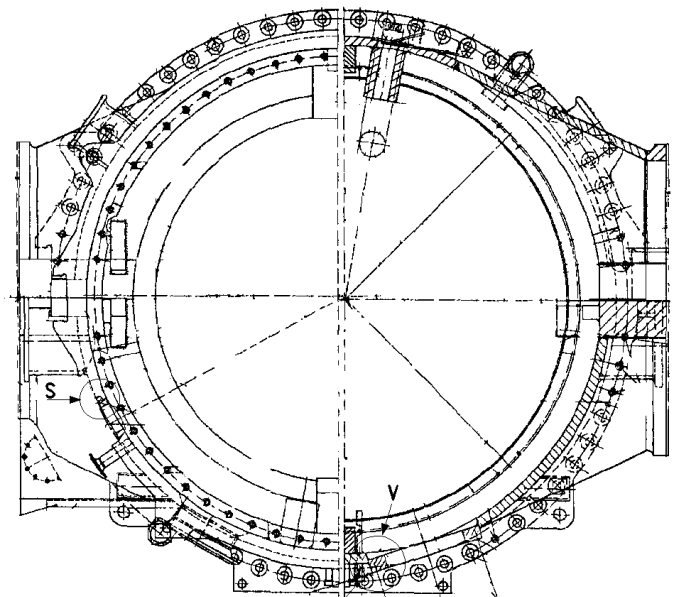

951  
70  
71  
PART. S

SECTION M1-M1

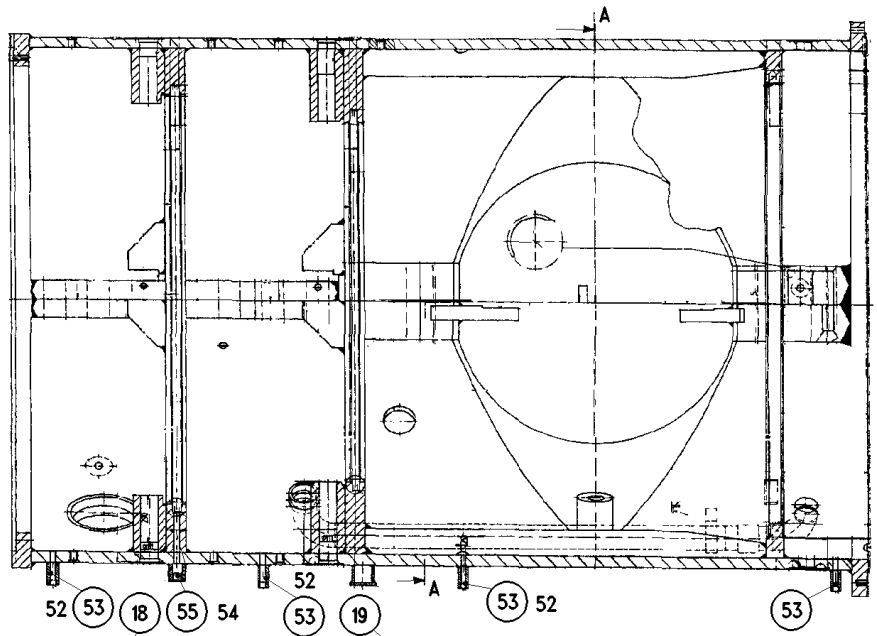
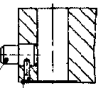
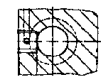

25  
26

PART. V

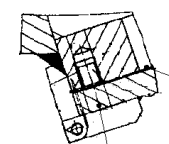

24

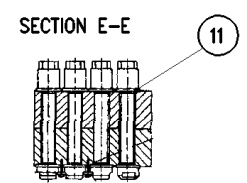
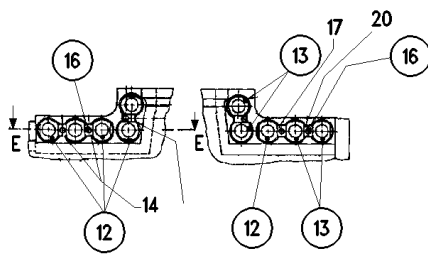

30 = VARNISH

CASSA ESTERNA CENTRALE  
CENTRE CASING

**MBA19HA009G**

